

REV	CHANGE	DATE	DRN	CHK
	Drawn	02/08/17	SJ	T

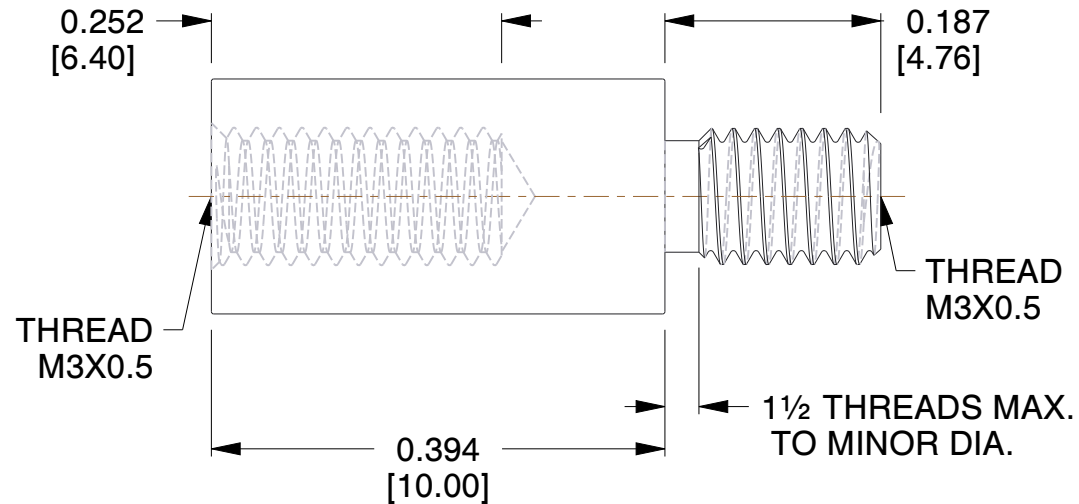
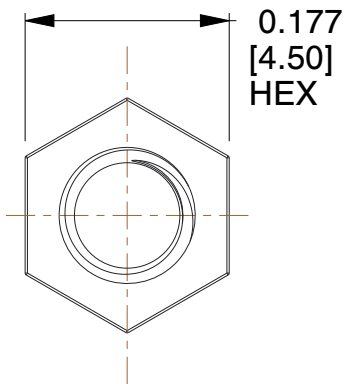
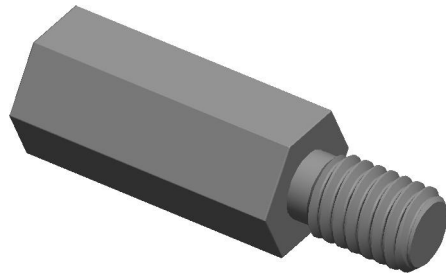

**NOTES:**

1. Material : Stainless Steel
2. Finish : No Plate
3. ASME Y14.5M - 2009
4. All Drawing Dimensions are in Inches [mm]
5. Unless otherwise specified; Edge Breaks, Radii or Countersinks 0.005-0.015

COMPONENT	STANDOFFS
<b>M2105-3005-SS</b>	<b>SCALE</b>
	6.00
	<b>SHEET</b>
4.5 MM HEX MALE-FEMALE STANDOFFS	
1 of 1	



95 Silvermine Rd., Seymour CT 06483  
Tel: 203-888-2133, Fax: 203-888-9860

This Drawing is the Property of RAF. It contains confidential, proprietary information that is RAF property. Do not disclose to or duplicate for others except as authorized by RAF.

**TOLERANCES**  
ALL DIMENSIONS ARE INCHES (UNLESS OTHERWISE SPECIFIED)  
**METALLIC**  
LENGTHS <math>\leq 6</math> INCHES  $\pm 0.005$   
LENGTH > 6 INCHES  $\pm 0.010$   
DIAMETERS:  $\pm 0.005$   
**NON-METALLIC**  
LENGTH:  $\pm 0.010$  DIAMETERS:  $\pm 0.010$   
**INTERNAL THREADS:**  
MINIMUM THREAD DEPTH