

# PN4258

## PNP Switching Transistor

- This device is designed for very high speed saturated switching at collector currents to 100mA.
- Sourced from process 65.

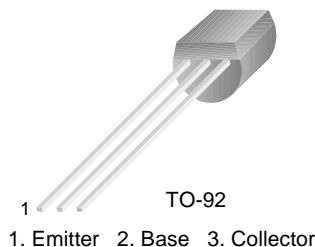

### Absolute Maximum Ratings\* $T_A=25^\circ\text{C}$ unless otherwise noted

Symbol	Parameter	Value	Units
$V_{CEO}$	Collector-Emitter Voltage	-12	V
$V_{CBO}$	Collector-Base Voltage	-12	V
$V_{EBO}$	Emitter-Base Voltage	-4.5	V
$I_C$	Collector Current - Continuous	-200	mA
$T_J, T_{STG}$	Operating and Storage Junction Temperature Range	- 55 ~ 150	$^\circ\text{C}$

\* These ratings are limiting values above which the serviceability of any semiconductor device may be impaired.

#### NOTES:

1. These ratings are based on a maximum junction temperature of 150 degrees C.
2. These are steady state limits. The factory should be consulted on applications involving pulsed or low duty cycle operations

### Electrical Characteristics $T_A=25^\circ\text{C}$ unless otherwise noted

Symbol	Parameter	Test Condition	Min.	Max.	Units
<b>Off Characteristics</b>					
$V_{(BR)CES}$	Collector-Emitter Breakdown Voltage *	$I_C = -100\mu\text{A}, V_{BE} = 0$	-12		V
$V_{CEO(SUS)}$	Collector-Emitter Sustaining Voltage *	$I_C = -3.0\text{mA}, I_B = 0$	-12		V
$V_{(BR)CBO}$	Collector-Base Breakdown Voltage	$I_C = -100\mu\text{A}, I_E = 0$	-12		V
$V_{(BR)EBO}$	Emitter-Base Breakdown Voltage	$I_E = -100\mu\text{A}, I_C = 0$	-4.5		V
$I_{CES}$	Collector Cutoff Current	$V_{CE} = -6.0\text{V}, V_{BE} = 0$ $V_{CE} = -6.0\text{V}, V_{BE} = 0, T_A = 65^\circ\text{C}$		-0.01 -5.0	$\mu\text{A}$ $\mu\text{A}$
<b>On Characteristics</b>					
$h_{FE}$	DC Current Gain	$I_C = -1.0\text{mA}, V_{CE} = -0.5\text{V}$ $I_C = -10\text{mA}, V_{CE} = -3.0\text{V}$ $I_C = -50\text{mA}, V_{CE} = -1.0\text{V}$	15 30 30	120	
$V_{CE(sat)}$	Collector-Emitter Saturation Voltage	$I_C = -10\text{mA}, I_B = -1.0\text{mA}$ $I_C = -50\text{mA}, I_B = -5.0\text{mA}$		-0.15 -0.5	V V
$V_{BE(sat)}$	Base-Emitter Saturation Voltage	$I_C = -10\text{mA}, I_B = -1.0\text{mA}$ $I_C = -50\text{mA}, I_B = -5.0\text{mA}$	-0.75	-0.95 -1.5	V V
<b>Small Signal Characteristics</b>					
$f_T$	Current Gain Bandwidth Product	$I_C = -10\text{mA}, V_{CE} = -5.0\text{V}, f = 100\text{MHz}$ $I_C = -10\text{mA}, V_{CE} = -10\text{V}, f = 100\text{MHz}$	700 700		MHz MHz
$C_{iob}$	Input Capacitance	$V_{BE} = -0.5\text{V}, I_C = 0, f = 1.0\text{MHz}$		3.5	pF
$C_{cb}$	Collector-Base Capacitance	$V_{BE} = -5.0\text{V}, I_E = 0, f = 1.0\text{MHz}$		3.0	pF

**Electrical Characteristics**  $T_A=25^\circ\text{C}$  unless otherwise noted (Continued)

Symbol	Parameter	Test Condition	Min.	Max.	Units
<b>Switching Characteristics</b>					
$t_{on}$	Turn-on Time	$V_{CC} = -1.5\text{V}$ , $V_{BE(off)} = 0\text{V}$ $I_C = -10\text{mA}$ , $I_{B1} = -1.0\text{mA}$		15	ns
$t_d$	Delay Time			10	ns
$t_r$	Rise Time			15	ns
$t_{off}$	Turn-off Time	$V_{CC} = -1.5\text{V}$ , $I_C = -10\text{mA}$ , $I_{B1} = I_{B2} = -10\text{mA}$		20	ns
$t_s$	Storage Time			20	ns
$t_f$	Fall Time			10	ns
$t_s$	Storage Time	$I_C = -10\text{mA}$ , $I_{B1} = I_{B2} = -10\text{mA}$		20	ns

\* Pulse Test: Pulse Width  $\leq 300\text{ms}$ , Duty Cycle  $\leq 2.0\%$ **Thermal Characteristics**  $T_A=25^\circ\text{C}$  unless otherwise noted

Symbol	Parameter	Max.	Units
$P_D$	Total Device Dissipation	350	mW
	Derate above $25^\circ\text{C}$	2.8	$\text{mW}/^\circ\text{C}$
$R_{\theta JC}$	Thermal Resistance, Junction to Case	125	$^\circ\text{C}/\text{W}$
$R_{\theta JA}$	Thermal Resistance, Junction to Ambient	357	$^\circ\text{C}/\text{W}$

# Typical Characteristics

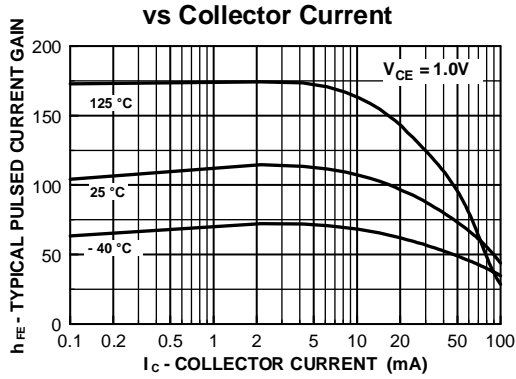

Figure 1. Typical Pulsed Current Gain vs Collector Current

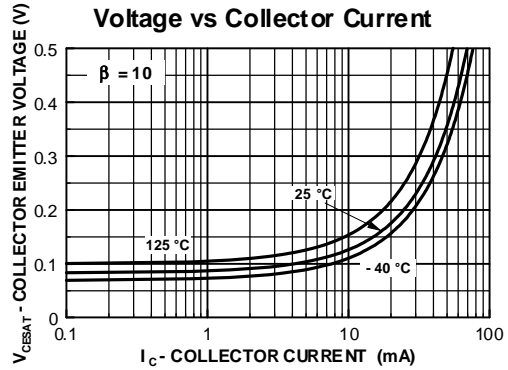

Figure 2. Collector-Emitter Saturation Voltage vs Collector Current

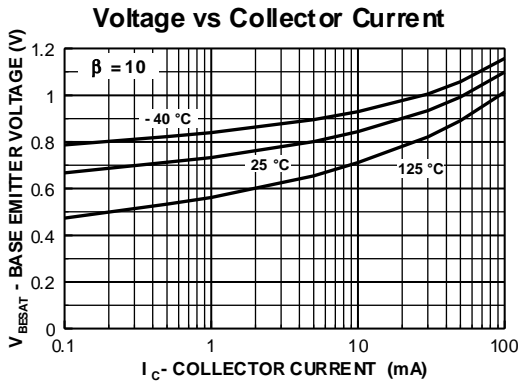

Figure 3. Base-Emitter Saturation Voltage vs Collector Current

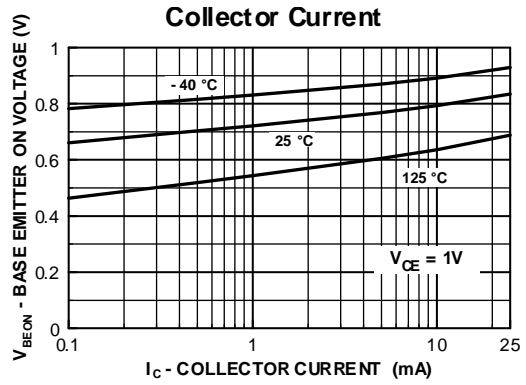

Figure 4. Base-Emitter On Voltage vs Collector Current

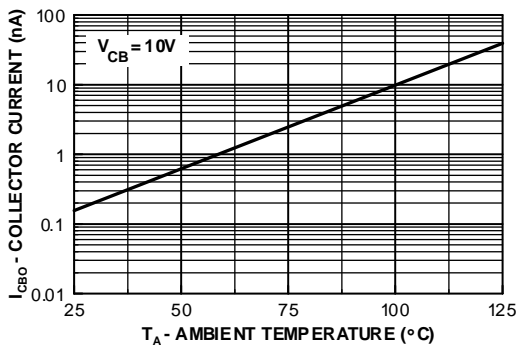

Figure 5. Collector Cutoff Current vs Ambient Temperature

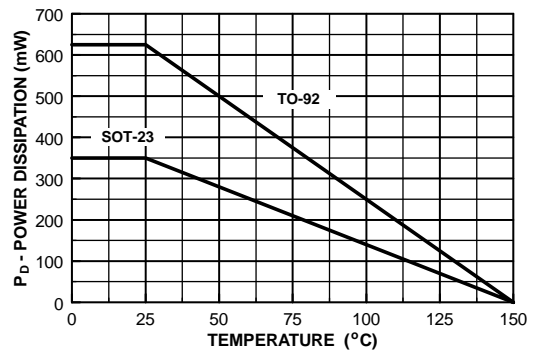

Figure 6. Power Dissipation vs Ambient Temperature

Typical Characteristics (Continued)

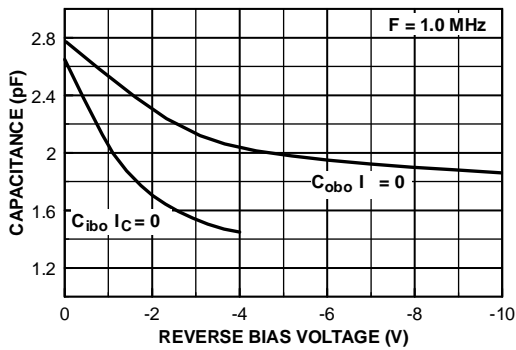

Figure 7. Input/Output Capacitance vs Reverse Bias Voltage

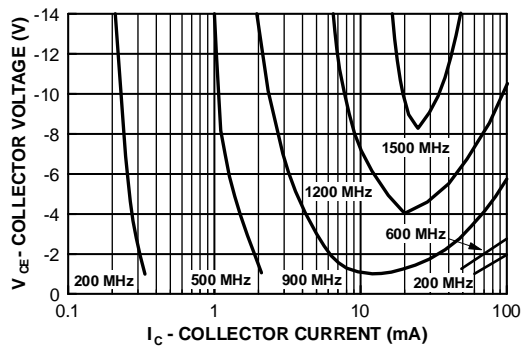

Figure 8. Contours of Constant Gain Bandwidth Product ( $f_T$ )

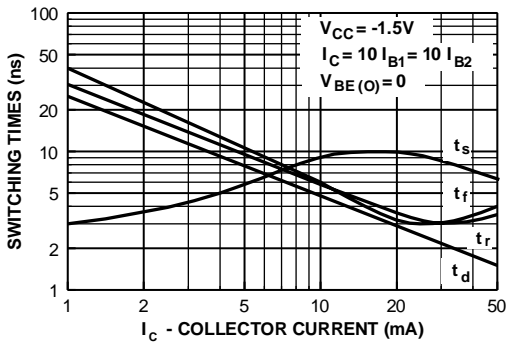

Figure 9. Switching Times vs Collector Current

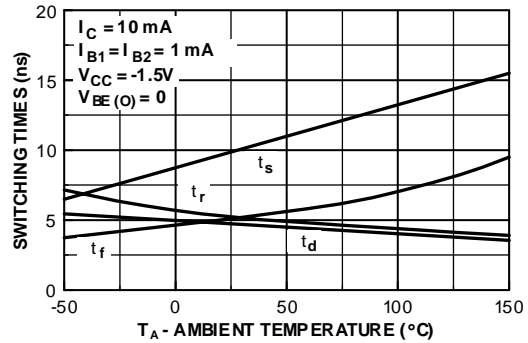

Figure 10. Switching Times vs Ambient Temperature

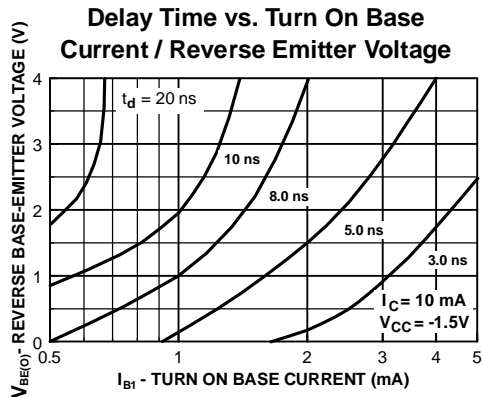

Figure 11. Delay Time vs Turn On Base Current/Reverse Emitter Voltage

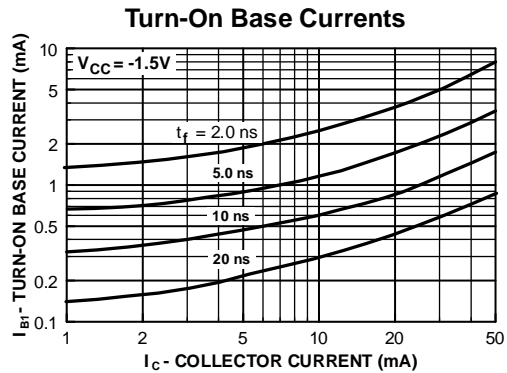

Figure 12. Rise Time vs Collector and Turn-On Base Currents

Typical Characteristics (Continued)

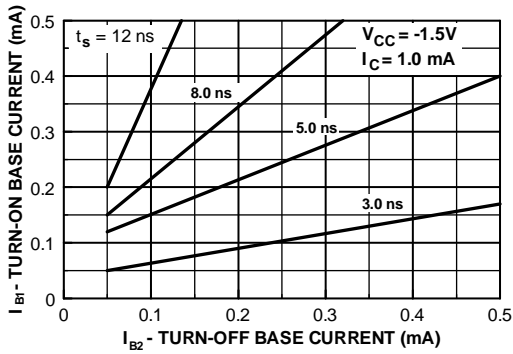

Figure 13. Storage Time vs Turn-On/Turn-Off Base Current

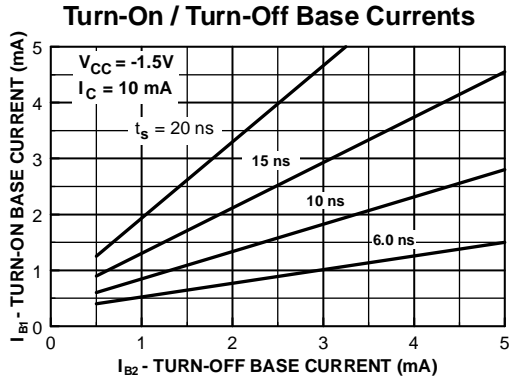

Figure 14. Storage Time vs Turn-On/Turn-Off Base Currents

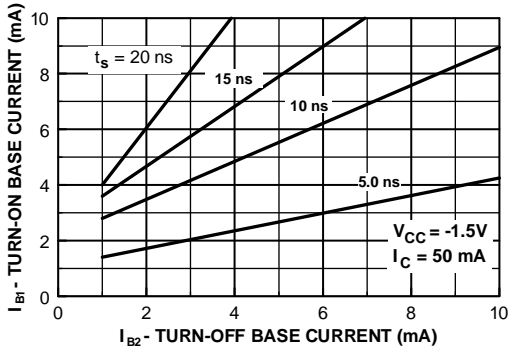

Figure 15. Storage Time vs Turn-On/Turn-Off Base Current

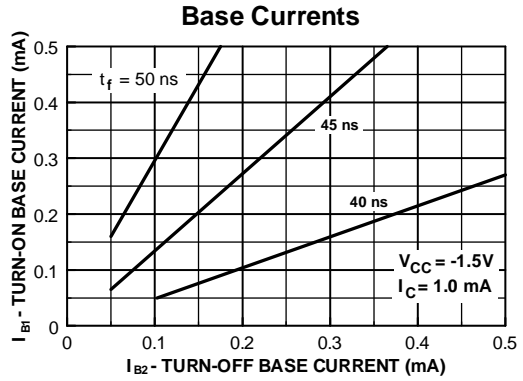

Figure 16. Fall Time vs Turn-On/Turn-Off Base Currents

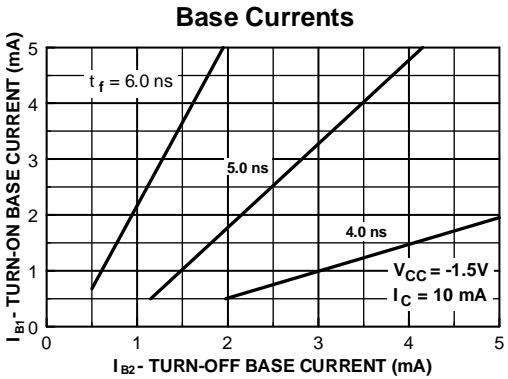

Figure 17. Fall Time vs Turn-On/Turn-Off Base Currents

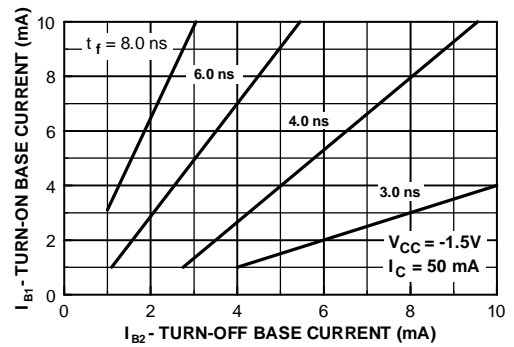

Figure 18. Fall Time vs Turn-On/Turn-Off Base Currents

# Test Circuit

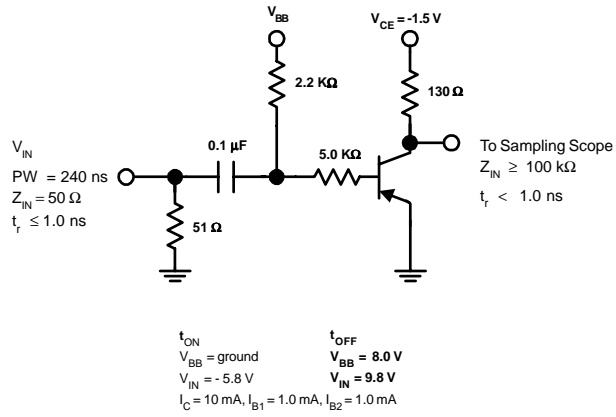
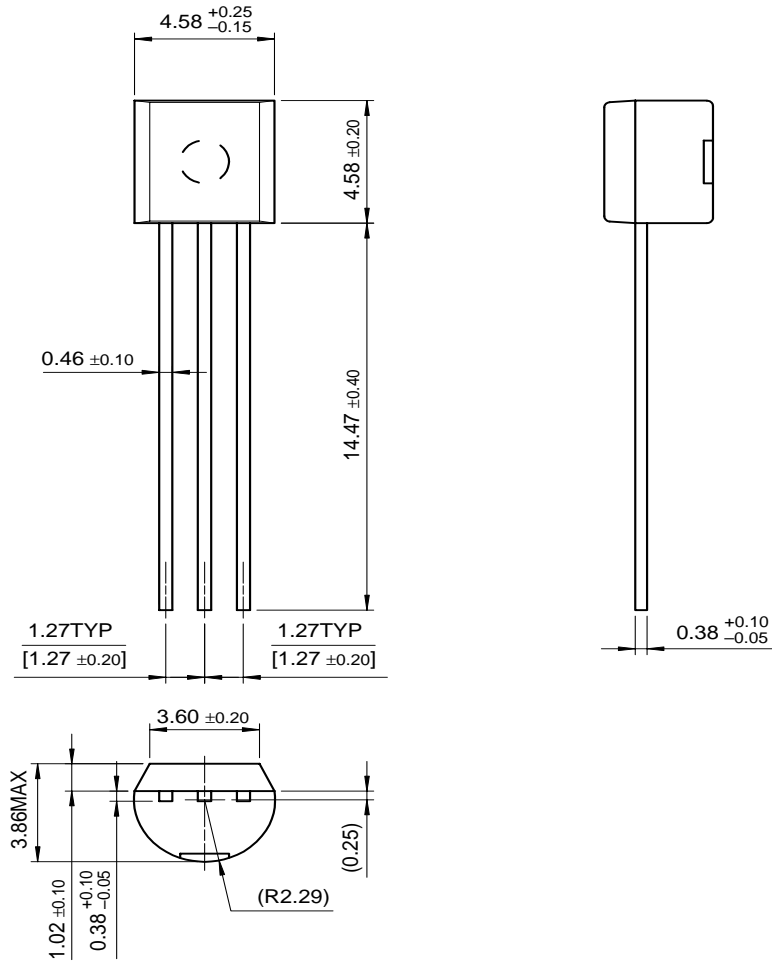

Figure 1.  $t_{on}$ ,  $t_{off}$  Test Circuit

# Package Dimensions

## TO-92



Dimensions in Millimeters

## TRADEMARKS

The following are registered and unregistered trademarks Fairchild Semiconductor owns or is authorized to use and is not intended to be an exhaustive list of all such trademarks.

ACE <sup>™</sup>	FACT <sup>™</sup>	ImpliedDisconnect <sup>™</sup>	PACMAN <sup>™</sup>	SPM <sup>™</sup>
ActiveArray <sup>™</sup>	FACT Quiet series <sup>™</sup>	ISOPLANAR <sup>™</sup>	POP <sup>™</sup>	Stealth <sup>™</sup>
Bottomless <sup>™</sup>	FAST <sup>®</sup>	LittleFET <sup>™</sup>	Power247 <sup>™</sup>	SuperSOT <sup>™</sup> -3
CoolFET <sup>™</sup>	FAST <sup>r</sup> <sup>™</sup>	MicroFET <sup>™</sup>	PowerTrench <sup>®</sup>	SuperSOT <sup>™</sup> -6
CROSSVOLT <sup>™</sup>	FRFET <sup>™</sup>	MicroPak <sup>™</sup>	QFET <sup>™</sup>	SuperSOT <sup>™</sup> -8
DOME <sup>™</sup>	GlobalOptoisolator <sup>™</sup>	MICROWIRE <sup>™</sup>	QS <sup>™</sup>	SyncFET <sup>™</sup>
EcoSPARK <sup>™</sup>	GTO <sup>™</sup>	MSX <sup>™</sup>	QT Optoelectronics <sup>™</sup>	TinyLogic <sup>™</sup>
E <sup>2</sup> CMOS <sup>™</sup>	HiSeC <sup>™</sup>	MSXPro <sup>™</sup>	Quiet Series <sup>™</sup>	TruTranslation <sup>™</sup>
EnSigna <sup>™</sup>	I <sup>2</sup> C <sup>™</sup>	OCX <sup>™</sup>	RapidConfigure <sup>™</sup>	UHC <sup>™</sup>
Across the board. Around the world. <sup>™</sup>		OCXPro <sup>™</sup>	RapidConnect <sup>™</sup>	UltraFET <sup>®</sup>
The Power Franchise <sup>™</sup>		OPTOLOGIC <sup>®</sup>	SILENT SWITCHER <sup>®</sup>	VCX <sup>™</sup>
Programmable Active Droop <sup>™</sup>		OPTOPLANAR <sup>™</sup>	SMART START <sup>™</sup>	

## DISCLAIMER

FAIRCHILD SEMICONDUCTOR RESERVES THE RIGHT TO MAKE CHANGES WITHOUT FURTHER NOTICE TO ANY PRODUCTS HEREIN TO IMPROVE RELIABILITY, FUNCTION OR DESIGN. FAIRCHILD DOES NOT ASSUME ANY LIABILITY ARISING OUT OF THE APPLICATION OR USE OF ANY PRODUCT OR CIRCUIT DESCRIBED HEREIN; NEITHER DOES IT CONVEY ANY LICENSE UNDER ITS PATENT RIGHTS, NOR THE RIGHTS OF OTHERS.

## LIFE SUPPORT POLICY

FAIRCHILD'S PRODUCTS ARE NOT AUTHORIZED FOR USE AS CRITICAL COMPONENTS IN LIFE SUPPORT DEVICES OR SYSTEMS WITHOUT THE EXPRESS WRITTEN APPROVAL OF FAIRCHILD SEMICONDUCTOR CORPORATION.

As used herein:

1. Life support devices or systems are devices or systems which, (a) are intended for surgical implant into the body, or (b) support or sustain life, or (c) whose failure to perform when properly used in accordance with instructions for use provided in the labeling, can be reasonably expected to result in significant injury to the user.
2. A critical component is any component of a life support device or system whose failure to perform can be reasonably expected to cause the failure of the life support device or system, or to affect its safety or effectiveness.

## PRODUCT STATUS DEFINITIONS

### Definition of Terms

Datasheet Identification	Product Status	Definition
Advance Information	Formative or In Design	This datasheet contains the design specifications for product development. Specifications may change in any manner without notice.
Preliminary	First Production	This datasheet contains preliminary data, and supplementary data will be published at a later date. Fairchild Semiconductor reserves the right to make changes at any time without notice in order to improve design.
No Identification Needed	Full Production	This datasheet contains final specifications. Fairchild Semiconductor reserves the right to make changes at any time without notice in order to improve design.
Obsolete	Not In Production	This datasheet contains specifications on a product that has been discontinued by Fairchild semiconductor. The datasheet is printed for reference information only.